

[Click Here To View
More Information](#)

[Click Here To View All
Fellowes Office Products](#)

Help Line

Australia	+ 1-800-33-11-77
Canada	+ 1-800-665-4339
México	+ 1-800-234-1185
United States	+ 1-800-955-0959

Fellowes

Australia	+ 61-3-8336-9700
Benelux	+ 31-(0)-76-523-2090
Canada	+ 1-905-475-6320
Deutschland	+ 49-(0)-5131-49770
France	+ 33-(0)-1-30-06-86-80
Italia	+ 39-(0)-71-730041
Japan	+ 81-(0)-3-5496-2401
Korea	+ 82-(0)-2-3462-2884
Malaysia	+ 60-(0)-35122-1231
Polska	+ 48-(22)-771-47-40
Spain	+ 34-91-748-05-01
Singapore	+ 65-6221-3811
United Kingdom	+ 44-(0)-1302-836836
United States	+ 1-630-893-1600



120-2 / C-120
120C-2 / C-120C

www.fellowes.com

Fellowes 1789 Norwood Avenue Itasca, Illinois 60143-1095 630-893-1600 <http://www.fellowes.com>
Australia Benelux Canada France Deutschland Italia Japan Korea Polska Singapore United Kingdom

© 2005 Fellowes Printed in China. Form No. 401113

BuyOnlineNow.com

Get More Done Today™

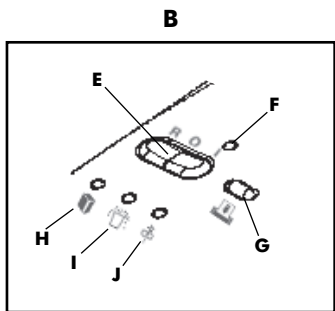
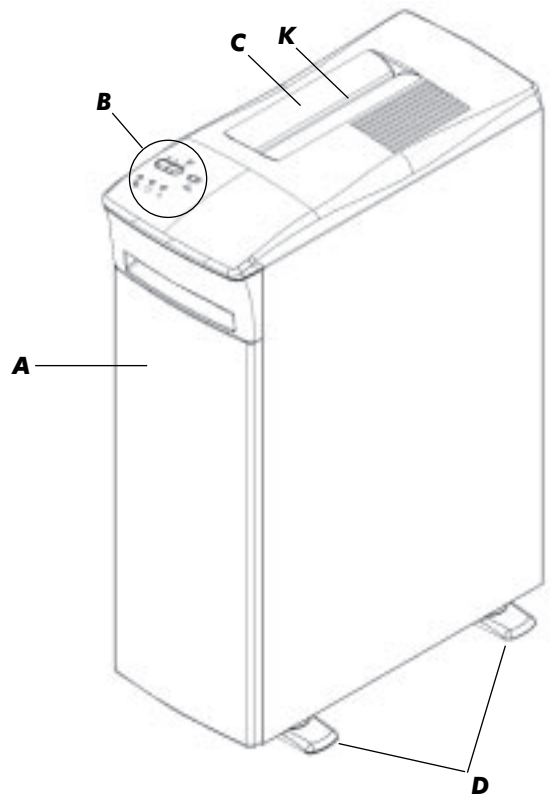

Fellowes

Dear Customer,

Thank you for buying a Fellowes Commercial Shredder. We have made many improvements in our commercial shredder since its introduction in 1982. We are confident that it offers you the greatest value for your money in its product category today. We hope it meets – or even exceeds – your expectations.

To ensure years of safe, efficient use, please read these few pages about your new shredder. If this manual doesn't answer all your questions or if you wish to comment on this product, we welcome your call or letter.

Sincerely,

James Fellowes
Chairman & CEO

Contents

Product Profile	3
Important Safety Instructions	3
Set-Up	4
Operation	4
Maintenance	5
Troubleshooting	6
Supplies	6
Warranty	7

Product Profile

This product is built to shred **paper, staples, small paper clips and credit cards**. It is not built to shred adhesive labels, transparencies, newspaper, cardboard, large paper clips, or plastic (other than credit cards). Attempting to shred items not intended for this shredder may cause damage.



	Strip-cut (120-2/C-120)	Confetti-cut (120C-2/C-120C)
Paper		
Sheet capacity*	18-20 sheets	12-14 sheets
Paper shred size	7/32" (5.8 mm)	5/32" x 1" (3.9 x 25 mm)
Maximum paper width	9.5" (241 mm)	9.5" (241 mm)
Recommended daily capacity	4,000 sheets	2,000 sheets
Credit Cards		
Credit card capacity	1	1
Recommended daily capacity	10	10

*Based on 20 lb., 8-1/2" x 11" paper with shredder operating at rated voltage; heavier paper, high humidity, or other than rated voltage may reduce sheet capacity.

⚠ IMPORTANT SAFETY INSTRUCTIONS READ ALL INSTRUCTIONS BEFORE USING

While setting up shredder

- Check shredder for damage or defects; some paper particles in the basket are normal due to product testing and does not indicate a defect.
- Avoid touching exposed blades on underside of confetti-cut shredder head.
- Plug power cord in an outlet that can easily be reached. The plug is the primary electrical disconnect.
- Make sure the electrical rating listed on the serial label (located inside, just below top of shredder) matches the available electric power.
- Do not place shredder near or over a heat or water source.

While operating shredder

- Keep hands and hanging objects (jewelry, ties, loose clothing, long hair, etc.) away from paper entry.
- Keep children and pets away from the shredder.



When not in use

- Always turn off and unplug shredder
- Unplug before emptying basket
- Do not open shredder head: Danger of electric shock. Opening shredder head will void the warranty.



NOTE: Do not use flammable synthetic oil, petroleum-based products or aerosols of any kind on or near product at any time.



Set-Up

- Turn retractable feet (D) to outward position. This will improve stability. The feet should be turned outward if shredder will not be placed between furniture.
- Pull waste basket drawer (A) completely out of cabinet.
- Put waste bag in basket (sample bags provided). Allow edges to overhang. Contact Fellowes to order more bags. (Part #36054).
- Slide waste basket drawer (A) into cabinet. The shredder will not operate if drawer is not pushed all the way into cabinet.
- Plug power cord into a convenient outlet.



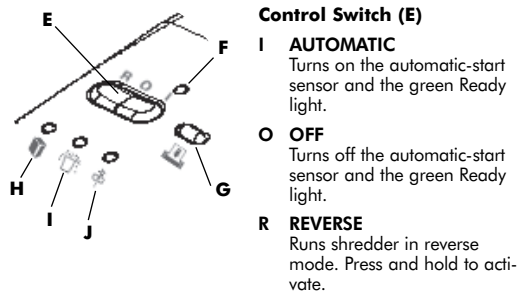

Operation

Control Switches



Turbo Jam Release Button (G)
Runs shredder when button is held down.

Troubleshooting Lights

 Ready Light (F) (Green) Shredder is in automatic start mode.	 Basket Ajar (H) Waste basket drawer is open.	 Basket Full (I) Waste basket is full or paper has collected under cutting cylinders.	 Paper Jam (J) Shredder is jammed (e.g., too much paper fed at one time).
--	--	--	--

For convenience and energy savings, your shredder is equipped with an **automatic-start sensor (K)**. This means that when the control switch (E) is in the automatic [I] position, the shredder will start running when you put paper into it and stop a few seconds after the paper has passed through.

CAUTION: The automatic-start sensor cannot tell the difference between paper and other objects. This feature can also be a hazard. Always turn off the shredder when it is not in use. Unplug the shredder if it will not be used for an extended period.

To shred

- Press control switch (E) to automatic [I] position. Green ready light (F) should turn on.
- Feed paper straight into entry (C), releasing when shredder begins shredding; see *Product Profile* for limits on paper width, shreddable items, sheet capacity, etc.

To empty waste basket

If basket full light (I) is on, follow these steps until light turns off.



- 1 • Press Turbo Jam Release Button (G) to finish shredding any paper in paper entry.
 - Press control switch (E) to the off [O] position.
 - Open the waste basket drawer (A) and remove full bag.
 - Place new bag in basket, then slide drawer into cabinet.
- 2 • Press and hold control switch (E) in the reverse [R] position for a few seconds to clear paper shreds that have collected under cutting cylinders.
 - Alternate between manual forward (G) and reverse [R] for a few seconds in each position.
- 3 • Unplug shredder and remove wastebasket drawer (A).
 - Carefully clear any paper shreds that have collected on under side of paper entry (C).

CAUTION: The shredder may be damaged if you alternate too rapidly between forward and reverse.

CAUTION: Models 120C-2/C-120C (confetti cut model) has exposed blades. Use care when removing paper shreds on underside of paper entry.

To clear a paper jam



If paper jam light (J) is on, follow these steps until light turns off.

- Check the waste basket and empty if full.
- Press and hold control switch (E) in the reverse [R] position to back paper out of paper entry (C). Try pulling gently on paper to remove it from shredder.
- Alternate between forward and reverse, if needed:
 - Press and hold Turbo Jam Release Button (G) for a few seconds.
 - Press and hold control switch (E) in the reverse [R] position for a few seconds.
 - Continue alternating between forward and reverse until the jam clears.

CAUTION: The shredder may be damaged if you alternate too rapidly between forward and reverse.

Maintenance

Empty waste basket regularly to ensure the smooth functioning of the cutting cylinders. The shredder will not operate when the basket is full.

Oil **confetti-cut model (120C-2/C-120C)** regularly to ensure proper operation. If used at or near daily capacity, apply oil every time you empty the basket. Use Fellowes Powershred Lubricant #35250 or other non-aerosol vegetable-based oil in a long-nozzle container (sample oil provided).





CAUTION: Do not use flammable synthetic oil, petroleum-based products, or aerosol lubricants of any kind.

To oil the cutting cylinders

- Apply oil over full width of cutting cylinders through the paper entry (C).
- Press and hold the Turbo Jam Release Button (G) for at least 3 seconds.
- Press and hold the control switch (E) in reverse [R] for at least 3 seconds.
- Repeat the forward/reverse sequence 3 or more times.

Troubleshooting

If there is a problem with your shredder, check these symptoms and remedies. If you cannot solve the problem, call your local dealer or contact Fellowes directly. **Do not open shredder head** to attempt repair. You could be exposed to serious electric shock and will void the warranty.

Symptom	Remedy
Ready Light (F) will not light	Make sure shredder is plugged in and the control switch (E) is in the automatic [I] position.
Shredder does not start or stops while shredding	<ul style="list-style-type: none"> • Make sure shredder is plugged in and control switch (E) is in the automatic [I] position. • Shredder is jammed. Follow the instructions under <i>Operation</i>.
Basket ajar light (H) is on 	Make sure the waste basket drawer (A) is all the way into the cabinet.
Basket full light (I) is on 	Empty the waste basket. Follow the instructions under <i>Operation</i> .
Paper jam light (J) is on 	Clear the paper jam. Follow the instructions under <i>Operation</i> .
Confetti-cut shredder (120C-2/C-120C) Shredder sheet capacity decreases, noise level increases, or cutting cylinders stop with a squeak or rubbing sound	Oil the cutting cylinders. Follow the instructions under <i>Maintenance</i> .
Shredder runs for a few seconds after the paper has cleared the cutters	No action required. This is a self-cleaning function.

Supplies

The following items for the 120-2/C-120 and 120C-2/C-120C shredders are available from Fellowes:

Item	Quantity	Part Number
Waste bags (in dispenser)	50/roll	36054
Waste basket (box)	1 box	400008
Powershred Lubricant (120C-2/C-120)	12 oz. bottle	35250

To purchase supplies, contact Fellowes at the appropriate location listed on the back page of this instruction manual, or visit us at www.fellowes.com.

Fellowes conducts extensive testing to ensure that these shredders are capable of meeting all of the specifications listed in the Product Profile (see page 2). However, the actual sheet capacity is dependent on a number of factors including the type and weight of paper, the humidity, the voltage level of the power source, the temperature of the motor, and the care with which the operator feeds the paper. Safety agency testing is conducted to ensure that the shredder will operate to specifications even if the available voltage is 10% below or 6% above the rated voltage. During this testing 2.5 minutes was taken to empty the basket each time it filled and the following capacities were used for temperature rise testing:

Voltage	Hertz	Cut Size & Type	Number of Sheets	Paper Size & Weight
220-240VAC	50HZ	3.9mm Strip Cut	17	A4 70g.
220-240VAC	50HZ	5.8mm Strip Cut	19	A4 70g.
220-240VAC	50HZ	3.9mm Confetti Cut	13	A4 70g.
120V	60Hz	5.8mm Strip Cut	19	8.5x11 20 lb.
120V	60Hz	3.9mm Confetti Cut	13	8.5x11 20 lb.
100V	50/60Hz	3.9mm Strip Cut	17	A4 70g.
100V	50/60Hz	3.9mm Confetti Cut	13	A4 70g.

Warranty

Fellowes, Inc. ("Fellowes") warrants the cutting cylinders of the machine to be free from defects in material and workmanship for 20 years from the date of purchase by the original consumer. Fellowes warrants all other parts of the machine to be free of defects in material and workmanship for 2 years from the date of purchase by the original consumer. If any part is found to be defective during the warrant period, your sole and exclusive remedy will be repair or replacement, at Fellowes' option and expense, of the defective part.

This warranty does not apply in cases of abuse, mishandling, or unauthorized repair. ANY IMPLIED WARRANTY, INCLUDING THAT OF MERCHANTABILITY OR FITNESS FOR A PARTICULAR PURPOSE, IS HEREBY LIMITED IN DURATION TO THE APPROPRIATE WARRANTY PERIOD SET FORTH ABOVE. In no event shall Fellowes be liable for any consequential or incidental damages attributable to this product. This warranty gives you specific legal rights. You may have other legal rights that vary from state to state.

For more detail or to obtain service under this warranty, please contact the appropriate location listed in the Contact for Service section of this instruction manual.

Warrantor: Fellowes, Inc.